

# 12

# Abstract

# Data Types

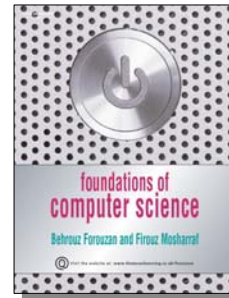

12.1

Source: Foundations of Computer Science © Cengage Learning

## Objectives

After studying this chapter, the student should be able to:

- Define **the concept of an abstract data type (ADT)**.
- Define a stack, **the basic operations on stacks**, their applications and how they can be implemented.
- Define a queue, **the basic operations on queues**, their applications and how they can be implemented.
- Define a general linear list, **the basic operations on lists**, their applications and how they can be implemented.
- Define **a general tree** and its application.
- Define a binary tree—a special kind of tree—and its applications.
- Define a **binary search tree (BST)** and its applications.
- Define a **graph** and its applications.

12.2

## 12-1 BACKGROUND

Problem solving with a computer means processing data. To process data, we need to **define the data type and the operation to be performed on the data**. The definition of the data type and the definition of the operation to be applied to the data is part of the idea behind an **abstract data type (ADT)** —to hide how the operation is performed on the data. In other words, **the user of an ADT needs only to know that a set of operations are available for the data type**, but does not need to know how they are applied.

12.3

### Simple ADTs

Many programming languages already define some simple ADTs as integral parts of the language. For example, **the C language defines a simple ADT as an integer**. The type of this ADT is an integer with predefined ranges. **C also defines several operations that can be applied to this data type** (addition, subtraction, multiplication, division and so on). C explicitly defines these operations on integers and what we expect as the results. A programmer who writes a C program to add two integers should know about the integer ADT and the operations that can be applied to it.

12.4

## Complex ADTs

Although several simple ADTs, such as integer, real, character, pointer and so on, have been implemented and are available for use in most languages, many useful complex ADTs are not. As we will see in this chapter, we need **a list ADT, a stack ADT, a queue ADT** and so on. To be efficient, these ADTs should be created and stored in the library of the computer to be used.

**The concept of abstraction means:**

- 1. We know what a data type can do.**
- 2. How it is done is hidden.**

12.5

## Definition

Let us now define an ADT. **An abstract data type is a data type packaged with the operations that are meaningful for the data type.** We then encapsulate the data and the operations on the data and hide them from the user.

**Abstract data type:**

- 1. Definition of data.**
- 2. Definition of operations.**
- 3. Encapsulation of data and operation.**

12.6

## Model for an abstract data type

The ADT model is shown in Figure 12.1. Inside the ADT are two different parts of the model: **data structure** and **operations** (public and private).

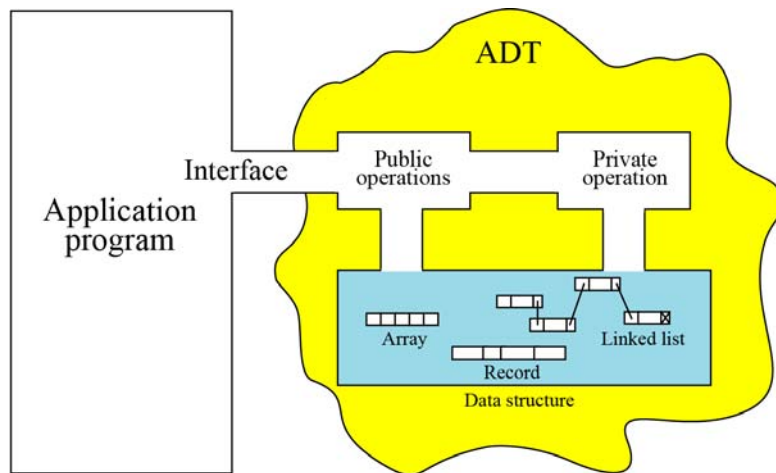

Figure 12.1 The model for an ADT

12.7

## Implementation

Computer languages do not provide complex ADT packages. To create a complex ADT, it is first implemented and kept in a library. The main purpose of this chapter is to introduce some common user-defined ADTs and their applications. However, we also give a brief discussion of each ADT implementation for the interested reader. We offer the pseudocode algorithms of the implementations as challenging exercises.

12.8

## 12-2 STACKS

**A stack is a restricted linear list** in which all additions and deletions are made at one end, the top. If we insert a series of data items into a stack and then remove them, the order of the data is reversed. This reversing attribute is why stacks are known as **last in, first out (LIFO) data structures.**

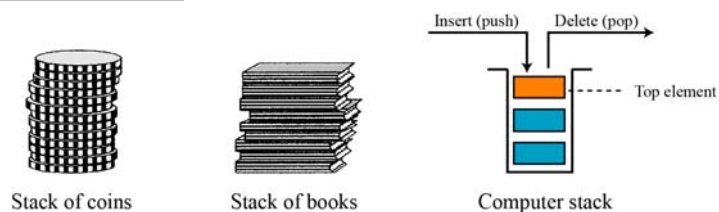

Figure 12.2 Three representations of stacks

12.9

### Operations on stacks

There are **four basic operations, *stack*, *push*, *pop* and *empty***, that we define in this chapter.

#### The *stack* operation

The ***stack*** operation **creates an empty stack**. The following shows the format.

`stack (stackName)`                      `stack(S)`

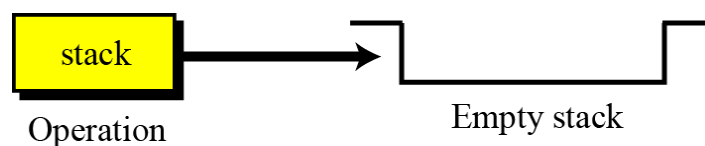

Figure 12.3 Stack operation

12.10

### The *push* operation

The *push* operation **inserts an item at the top of the stack**.  
The following shows the format.

**push (stackName, dataitem)**

**push(S,20)  
push(S,78)  
push(S,30)**

```
push (S,num)
{ top = top +1;
  S[top] = num;
}
```

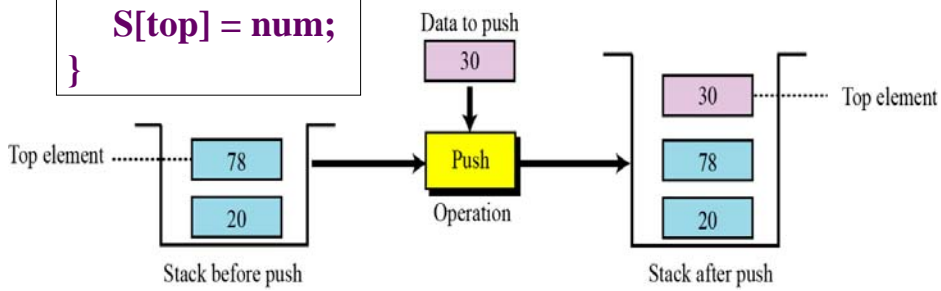

**Figure 12.4 Push operation**

12.11

### The *pop* operation

The *pop* operation **deletes the item at the top of the stack**.  
The following shows the format.

**pop (stackName, dataitem)**

```
pop (S)
{ num = S[top];
  top = top -1;
  return num;
}
```

**pop(S,x); // x=30**

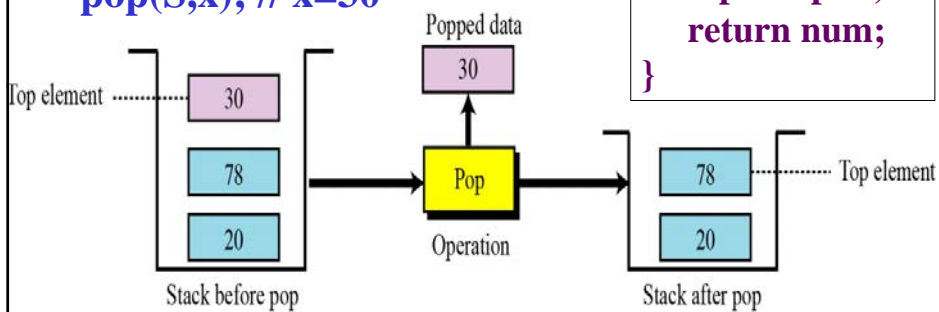

**Figure 12.5 Pop operation**

12.12

### The *empty* operation

The *empty* operation **checks the status of the stack**. The following shows the format.

**empty (stackName)**      **If empty(S)**

This operation returns **true** if the stack is empty and **false** if the stack is not empty.

12.13

### Stack ADT

We define a stack as an ADT as shown below:

#### *Stack ADT*

<b>Definition</b>	A list of data items that can only be accessed at one end, called the <i>top</i> of the stack.
<b>Operations</b>	<b>stack:</b> Creates an empty stack. <b>push:</b> Inserts an element at the top. <b>pop:</b> Deletes the top element. <b>empty:</b> Checks the status of the stack.

12.14

Give a stack  $S$  as below, after  $\text{Pop}(S)$ 、 $\text{Push}(S,25)$ 、 $\text{Push}(S,33)$ 、 $\text{Pop}(S)$ 、 $\text{Pop}(S)$  and  $\text{Pop}(S)$ ， $\text{Top} = \underline{\hspace{2cm}}$  及  $S[\text{top}] = \underline{\hspace{2cm}}$

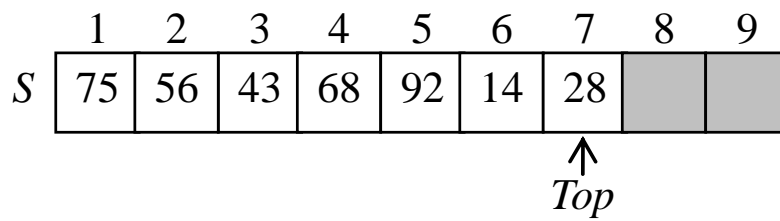

12.15

### Example 12.1

Figure 12.6 shows a segment of an algorithm that applies the previously defined operations on a stack  $S$ .

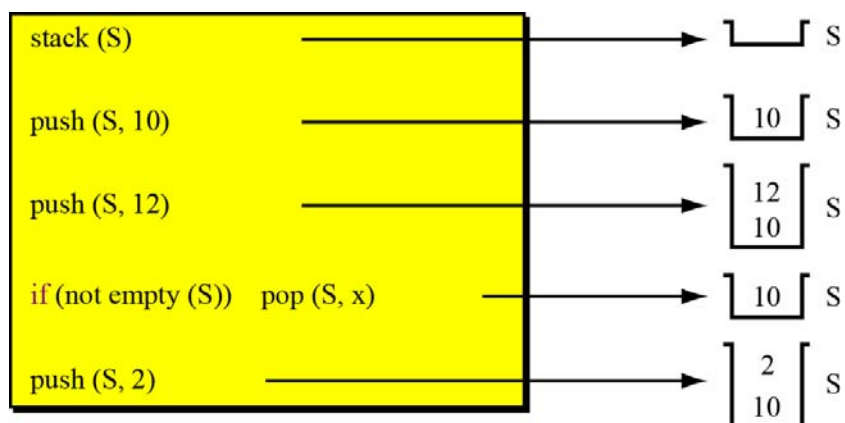

An algorithm segment

**Figure 12.6** Example 12.1

12.16



## Stack applications

Stack applications can be classified into four broad categories: reversing data, pairing data, postponing data usage and backtracking steps. We discuss the first two in the sections that follow.

### Reversing data items

Reversing data items requires that a given set of data items be reordered so that the first and last items are exchanged, with all of the positions between the first and last also being relatively exchanged.

For example,

the list (2, 4, 7, 1, 6, 8) becomes (8, 6, 1, 7, 4, 2).

12.17

### Example 12.2

#### Convert a decimal integer to binary and print the results

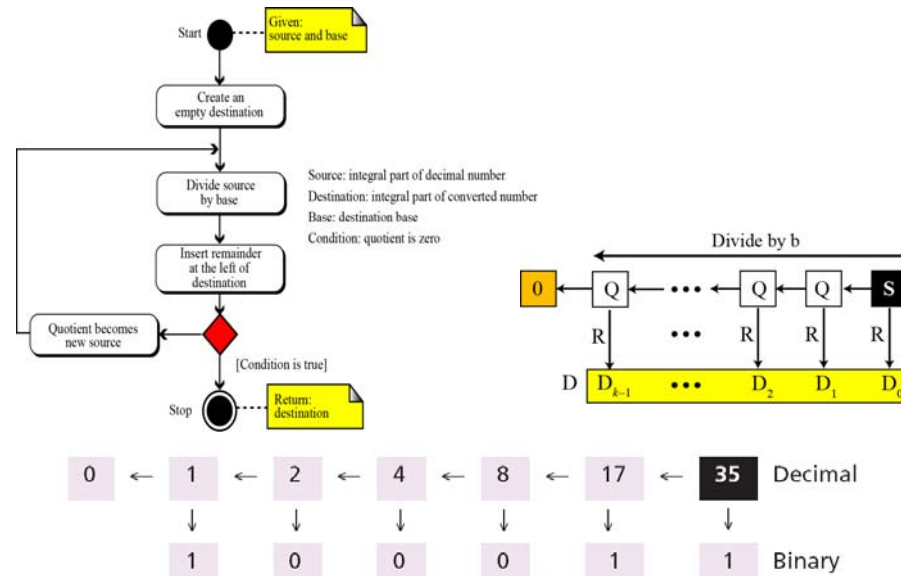

12.18

### Example 12.2 (Continued)

We can use the reversing characteristic of a stack (LIFO structure) to solve the problem.

**Algorithm 12.1 shows the pseudocode to convert a decimal integer to binary and print the result.** We create an empty stack first. Then we use a while loop to create the bits, but instead of printing them, we push them into the stack. When all bits are created, we exit the loop. Now we use another loop to pop the bits from the stack and print them. Note that the bits are printed in the reverse order to that in which they have been created.

12.19

### Algorithm 12.1 Example 12.2

**Algorithm:** DecimalToBinary (number)

**Purpose:** Print the binary equivalent of a given integer (absolute value)

**Pre:** Given the integer to be converted (number)

**Post:** The binary integer is printed

**Return:** None

```
{
    stack (S)
    while (number ≠ 0) //conversion of decimal to binary
    {
        remainder ← number mod 2
        push (S, remainder)
        number ← number / 2
    }
    while (not empty (S)) // output the binary
    {
        pop (S, x)
        print (x)
    }
    return
}
```

12.20

## Pairing data items

We often need to **pair some characters** in an expression. For example, when we write a mathematical expression in a computer language, we often need to use parentheses to change the precedence of operators. The following expression is evaluated because of the parentheses:

$$3 \times 6 + 2 = 20 \quad \longleftrightarrow \quad 3 \times (6 + 2) = 24$$

When we type an expression with a lot of parentheses, one of the duties of a compiler is to do the checking for us. The compiler uses a stack to check that all opening parentheses are paired with a closing parentheses.

### Example 12.3

**Algorithm 12.2** shows how we can check if all opening parentheses are paired with a closing parenthesis.

12.21

### Algorithm 12.2 Example 12.3

**Algorithm: CheckingParentheses** (expression)

**Purpose:** Check the pairing of parentheses in an expression

**Pre:** Given the expression to be checked

**Post:** Error messages if unpaired parentheses are found

**Return:** None

```
{
  stack (S)
  while (more character in the expression)
  {
    Char ← next character
    if (Char = '(')      push (S, Char)
    else
    {
      if (Char = ')')
      {
        if (empty (S))  print (unmatched opening parenthesis)
        else            pop (S, x)
      }
    }
  }
  if (not empty (S))   print (a closing parenthesis not matched)
  return
}
```

$3 \times (6 + 2)$

12.22

## Stack implementation

At the ADT level, we use the stack and its four operations; at the implementation level, we need to **choose a data structure** to implement it. Stack ADTs can be implemented using either an **array** or a **linked list**. Figure 12.7 shows an example of a stack ADT with five items. The figure also shows how we can implement the stack.

In our **array implementation**, we have a record that has two fields. The first field can be used to store information about the array. The linked list implementation is similar: we have an extra node that has the name of the stack. This node also has two fields: a counter and a pointer that points to the top element.

12.23

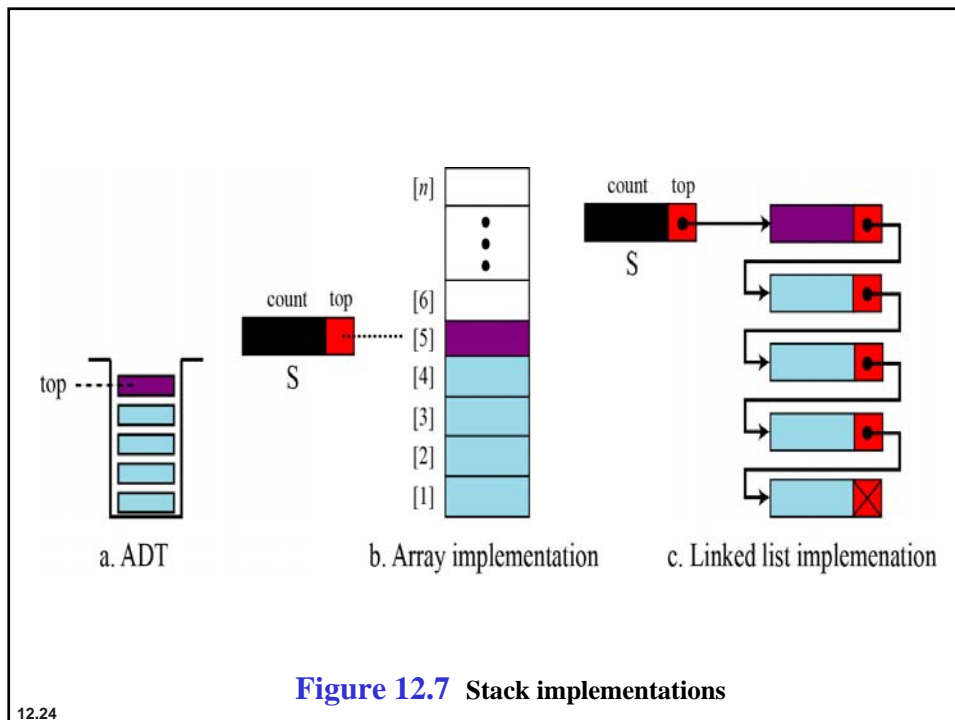

12.24

## 12-3 QUEUES

A **queue** is a linear list in which data can only be inserted at one end, called the **rear**, and deleted from the other end, called the **front**. These restrictions ensure that the data is processed through the queue in the order in which it is received. In other words, a queue is a **first in, first out (FIFO)** structure.

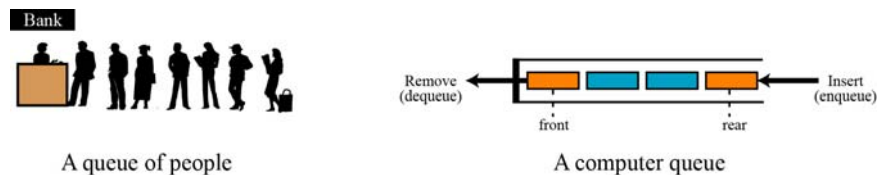

Figure 12.8 Two representation of queues

12.25

### Operations on queues

Although we can define many operations for a queue, four are basic: **queue**, **enqueue**, **dequeue** and **empty**, as defined below.

#### The **queue** operation

The **queue** operation creates an empty queue. The following shows the format.

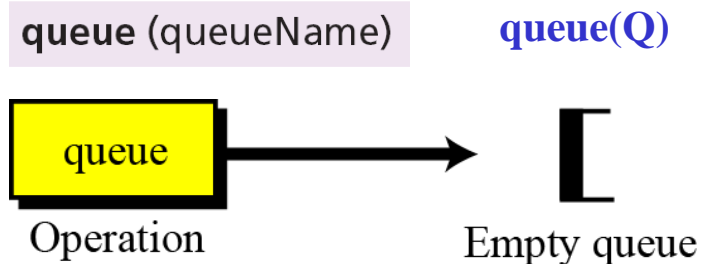

Figure 12.9 The queue operation

12.26

### The *enqueue* operation

The *enqueue* operation **inserts an item at the rear of the queue**. The following shows the format.

`enqueue (queueName, dataItem)`

`enqueue(Q,20)`  
`enqueue(Q,78)`  
`enqueue(Q,34)`

```
enqueue (Q,num)
{ rear = rear +1;
  if (front ==-1) front = rear;
  Q[rear] = num;
}
```

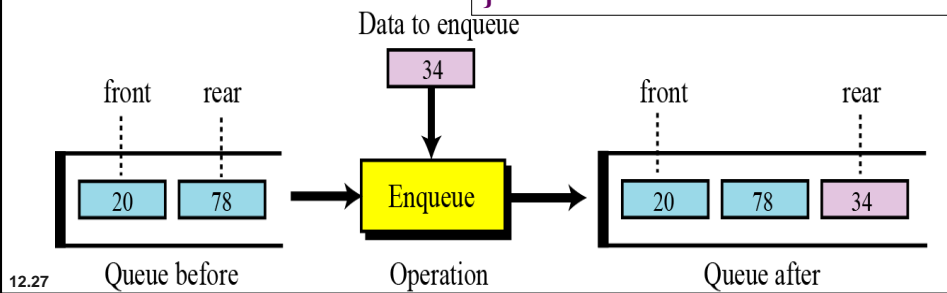

### The *dequeue* operation

The *dequeue* operation **deletes the item at the front of the queue**. The following shows the format.

`dequeue (queueName, dataItem)`

```
dequeue (Q)
{ num = Q[front];
  front = front +1;
  if (front ==-1) rear = front;
  return num;
}
```

`dequeue(Q,x) // x=20`

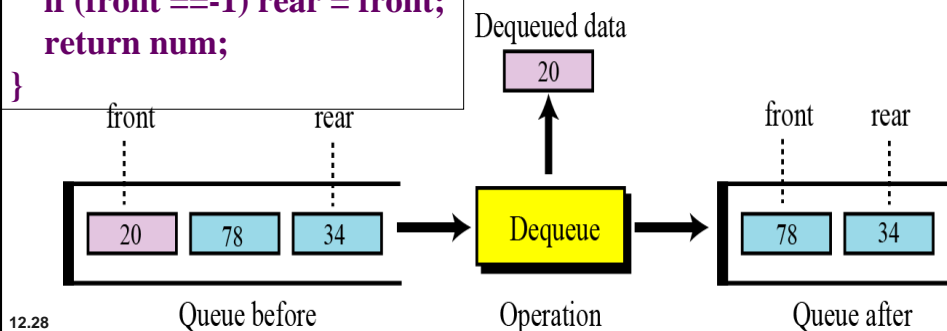

### The *empty* operation

The *empty* operation **checks the status of the queue**. The following shows the format.

`empty (queueName)`                      **if empty(Q)**

This operation returns true if the queue is empty and false if the queue is not empty.

12.29

### Queue ADT

We define a queue as an ADT as shown below:

#### Queue ADT

**Definition**                      A list of data items in which an item can be deleted from one end, called the *front* of the queue and an item can be inserted at the other end, called the *rear* of the queue.

**Operations**                      **queue:** Creates an empty queue.  
**enqueue:** Inserts an element at the rear.  
**dequeue:** Deletes an element from the front.  
**empty:** Checks the status of the queue.

12.30

### Example 12.4

Figure 12.12 shows a segment of an algorithm that applies the previously defined operations on a queue  $Q$ .

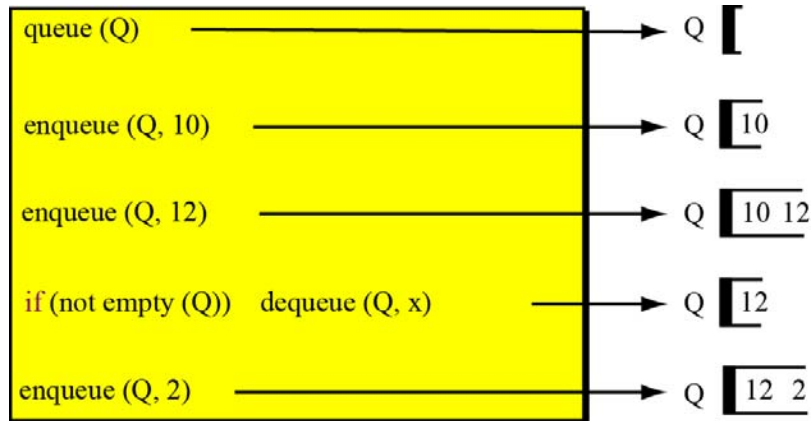

An algorithm segment

Figure 12.12 Example 12.4

12.31

Please show the contents of the queue  $Q$  after the operations of `enqueue(Q,54)`, `dequeue(Q)`, `enqueue(Q,71)`, `dequeue(Q)`, `dequeue(Q)`, and `enqueue(Q,33)`, and  $Front=?$  and  $Rear=?$ .

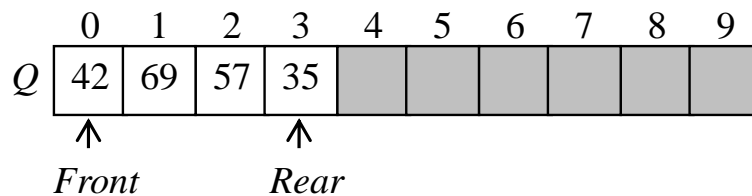

12.32



## Queue applications

Queues are one of the most common of all data processing structures. They are found in virtually every operating system and network and in countless other areas. For example, **queues are used in online business applications such as processing customer requests, jobs and orders.** In a computer system, a queue is needed to process jobs and for system services such as print spools.

### Example 12.5

Imagine we have a list of sorted data stored in the computer belonging to two categories: less than 1000, and greater than 1000. We can use two queues to separate the categories and at the same time maintain the order of data in their own category. **Algorithm 12.3 shows the pseudocode for this operation.**

12.33

**Algorithm:** Categorizer (list)

**Purpose:** Categorize data into two categories and create two separate lists

**Pre:** Given: original list

**Post:** Prints the two lists

**Return:** None

```
{
    queue (Q1)
    queue (Q2)
    while (more data in the list)
    {
        if (data < 1000)           enqueue (Q1, data)
        if (data ≥ 1000)         enqueue (Q2, data)
    }
    while (not empty(Q1))
    {
        dequeue (Q1, x)
        print (x)
    }
    while (not empty(Q2))
    {
        dequeue (Q2, x)
        print (x)
    }
    return
}
```

12.34

### Example 12.6

Another common application of a queue is to adjust and create a balance between a fast producer of data and a slow consumer of data. For example, assume that a CPU is connected to a printer. The speed of a printer is not comparable with the speed of a CPU. If the CPU waits for the printer to print some data created by the CPU, the CPU would be idle for a long time. The solution is a queue. The CPU creates as many chunks of data as the queue can hold and sends them to the queue. The CPU is now free to do other jobs. The chunks are dequeued slowly and printed by the printer. The queue used for this purpose is normally referred to as a spool queue.

12.35

### Queue implementation

At the ADT level, we use the queue and its four operations at the implementation level. We need to choose a data structure to implement it. A queue ADT can be implemented using either an array or a linked list. Figure 12.13 on page 329 shows an example of a queue ADT with five items. The figure also shows how we can implement it. In the **array implementation** we have a record with three fields. The first field can be used to store information about the queue.

The **linked list implementation** is similar: we have an extra node that has the name of the queue. This node also has three fields: a count, a pointer that points to the front element and a pointer that points to the rear element.

12.36

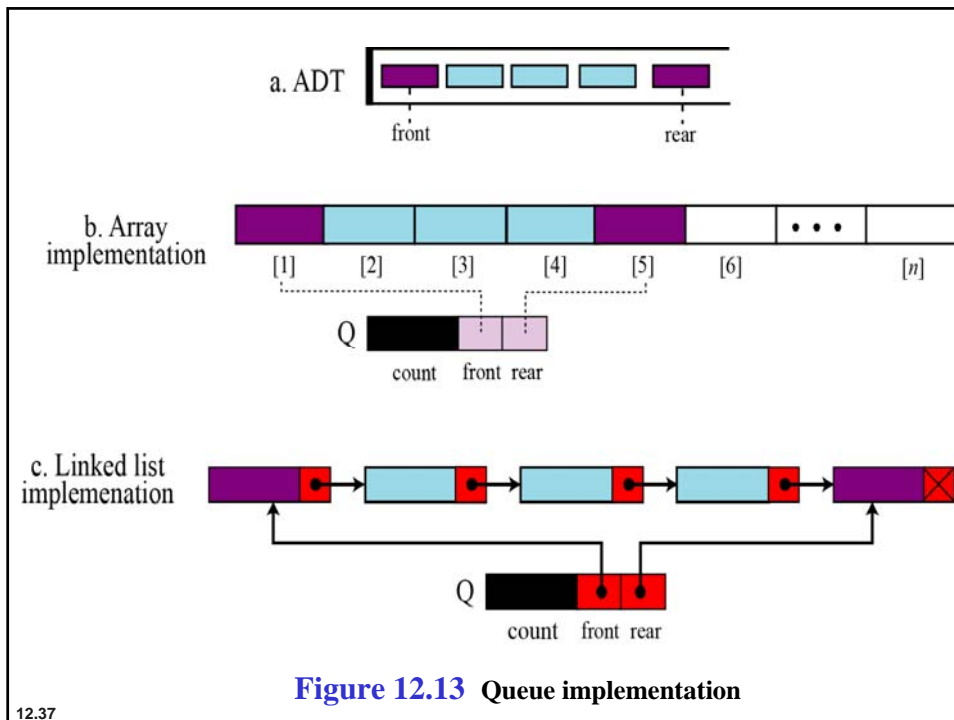

## 12-4 GENERAL LINEAR LISTS

Stacks and queues defined in the two previous sections are **restricted linear lists**. A **general linear list** is a list in which operations, such as **insertion** and **deletion**, can be done anywhere in the list—at the beginning, in the middle or at the end. Figure 12.14 shows a general linear list.

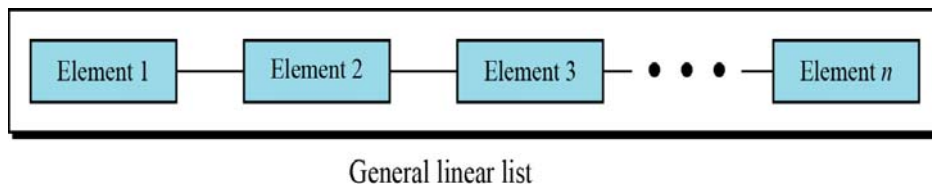

Figure 12.14 General linear list

12.38

## Operations on general linear lists

Although we can define many operations on a general linear list, we discuss only **six common operations** in this chapter: *list*, *insert*, *delete*, *retrieve*, *traverse* and *empty*.

### The *list* operation

The *list* operation **creates an empty list**. The following shows the format:

```
list (listName)
```

12.39

### The *insert* operation

Since we assume that data in a general linear list is **sorted**, insertion must be done in such a way that **the ordering of the elements is maintained**. To determine where the element is to be placed, searching is needed. However, searching is done at the implementation level, not at the ADT level.

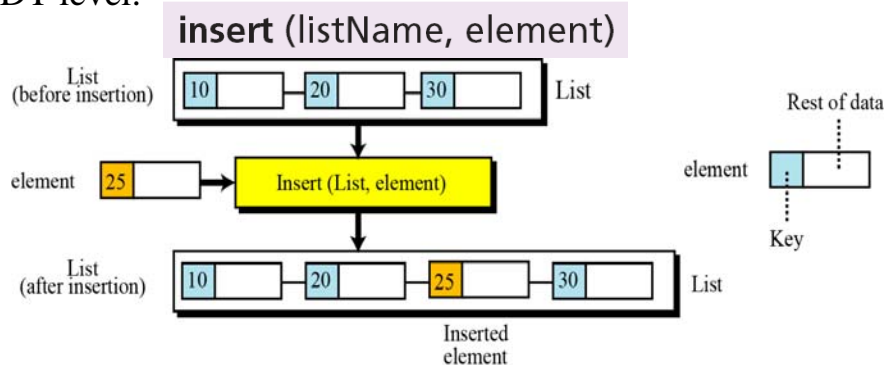

12.40

**Figure 12.15** The insert operation

### The *delete* operation

Deletion from a general list (Figure 12.16) also requires that the list be searched to locate the data to be deleted. After the location of the data is found, deletion can be done. The following shows the format:

**delete** (listName, target, element)

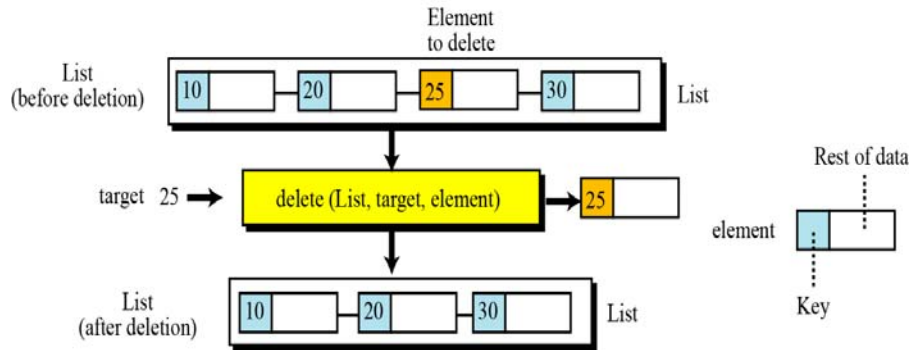

**Figure 12.16** The dequeue operation

12.41

### The *retrieve* operation

By retrieval, we mean access of a single element. Like insertion and deletion, the general list should be first searched, and if the data is found, it can be retrieved. The format of the retrieve operation is:

**retrieve** (listName, target, element)

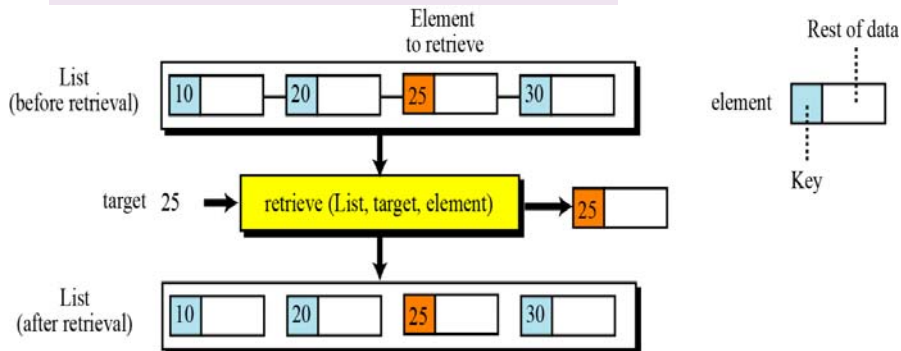

**Figure 12.17** The retrieve operation

12.42

### **The *traverse* operation**

Each of the previous operations involves a single element in the list, randomly accessing the list. List traversal, on the other hand, **involves sequential access**. It is an operation in which all elements in the list are processed one by one. The following shows the format:

```
traverse (listName, action)
```

12.43

### **The *empty* operation**

The empty operation **checks the status of the list**. The following shows the format:

```
empty (listName)
```

This operation returns true if the list is empty, or false if the list is not empty.

12.44

## General linear list ADT

We define a general linear list as an ADT as shown below:

### General linear list ADT

**Definition** A list of sorted data items, all of the same type.

**Operations** **list:** Creates an empty list.

**insert:** Inserts an element in the list.

**delete:** Deletes an element from the list.

**retrieve:** Retrieves an element from the list.

**traverse:** Traverses the list sequentially.

**empty:** Checks the status of the list.

12.45

### Example 12.7

Figure 12.18 shows a segment of an algorithm that applies the previously defined operations on a list L. Note that the third and fifth operation inserts the new data at the correct position, because the insert operation calls the search algorithm at the implementation level to find where the new data should be inserted. The fourth operation does not delete the item with value 3 because it is not in the list.

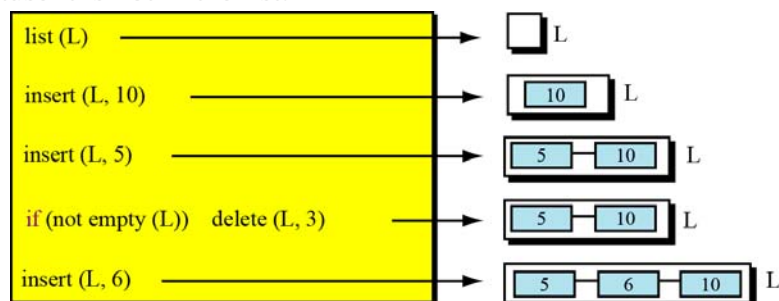

An algorithm segment

**Figure 12.18** Example 12.7

12.46

## General linear list applications

General linear lists are used in situations in which the elements are accessed randomly or sequentially. For example, in a college a linear list can be used to store information about students who are enrolled in each semester.

12.47

### Example 12.8

A college has a general linear list that holds information about the students and that each data element is a record with three fields: ID, Name and Grade. Algorithm 12.4 shows an algorithm that helps a professor to change the grade for a student. The delete operation removes an element from the list, but makes it available to the program to allow the grade to be changed. The insert operation inserts the changed element back into the list. The element holds the whole record for the student, and the target is the ID used to search the list.

12.48



### Example 12.8 (Continued)

#### Algorithm 12.4 Example 12.8

**Algorithm:** ChangeGrade (StudentList, target, grade)

**Purpose:** Change the grade of a student

**Pre:** Given the list of students and the grade

**Post:** None

**Return:** None

```
{
    delete (StudentList, target, element)
    (element.data).Grade ← grade
    insert (StudentList, element)
    return
}
```

12.49

### Example 12.9

Continuing with Example 12.8, assume that the tutor wants to **print the record of all students at the end of the semester.** Algorithm 12.5 can do this job. We assume that there is an algorithm called Print that prints the contents of the record. For each node, the list traverse calls the Print algorithm and passes the data to be printed to it.

**Algorithm:** PrintRecord (StudentList)

**Purpose:** Print the record of all students in the StudentList

**Pre:** Given the list of students

**Post:** None

**Return:** None

```
{
    traverse (StudentList, Print)
    return
}
```

12.5

## General linear list implementation

At the ADT level, we use the list and its six operations but at the implementation level we need to choose a data structure to implement it. **A general list ADT can be implemented using either an array or a linked list.** Figure 12.19 shows an example of a list ADT with five items. The figure also shows how we can implement it.

The linked list implementation is similar: we have an extra node that has the name of the list. This node also has two fields, a counter and a pointer that points to the first element.

12.51

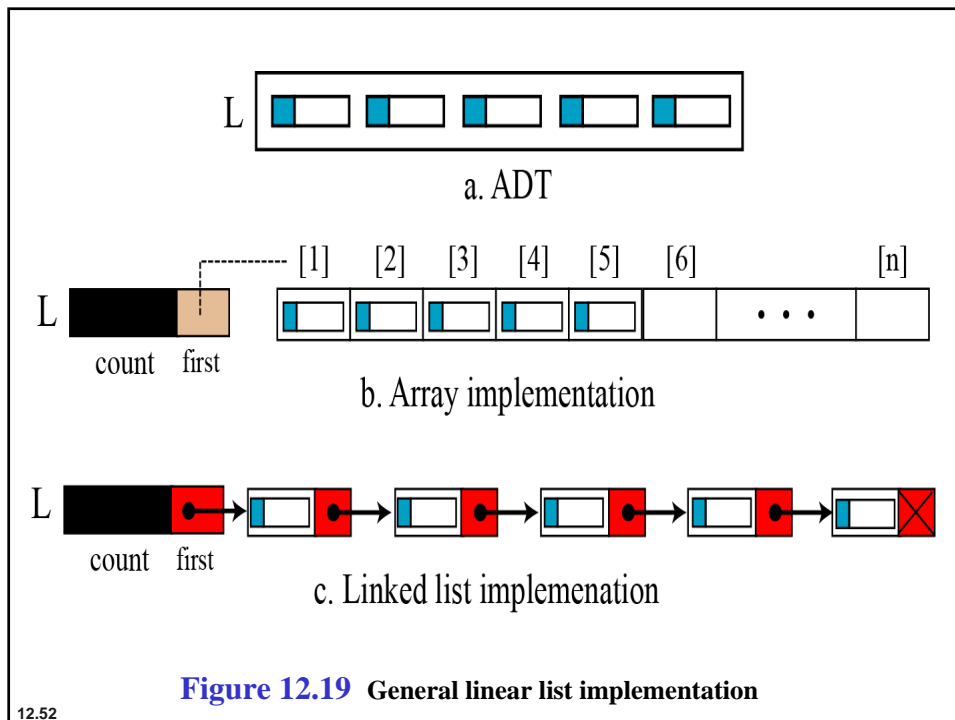

12.52

## 12-5 TREES

A **tree** consists of a finite set of elements, called **nodes** (or **vertices**) and a finite set of directed **lines**, called **arcs**, that connect pairs of the nodes.

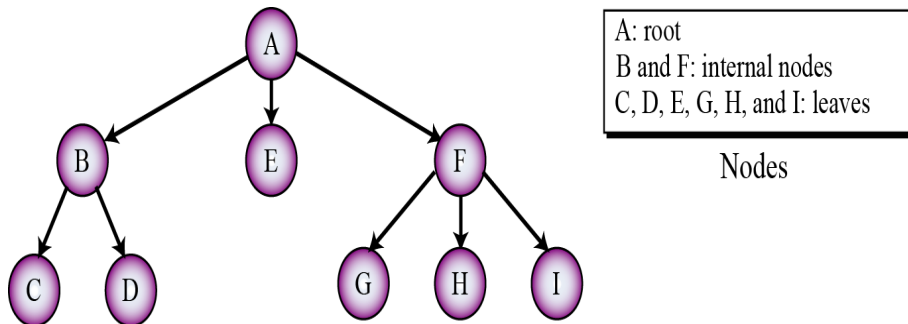

**Figure 12.20** Tree representation

12.53

We can divided the vertices in a tree into three categories: the **root**, **leaves** and the **internal nodes**. Table 12.1 shows the number of outgoing and incoming arcs allowed for each type of node.

**Table 12.1** Number of incoming and outgoing arcs

<i>Type of node</i>	<i>Incoming arc</i>	<i>Outgoing arc</i>
root	0	0 or more
leaf	1	0
internal	1	1 or more

12.54

Each node in a tree may have a **subtree**. The subtree of each node includes one of its children and all descendants of that child. Figure 12.21 shows all subtrees for the tree in Figure 12.20.

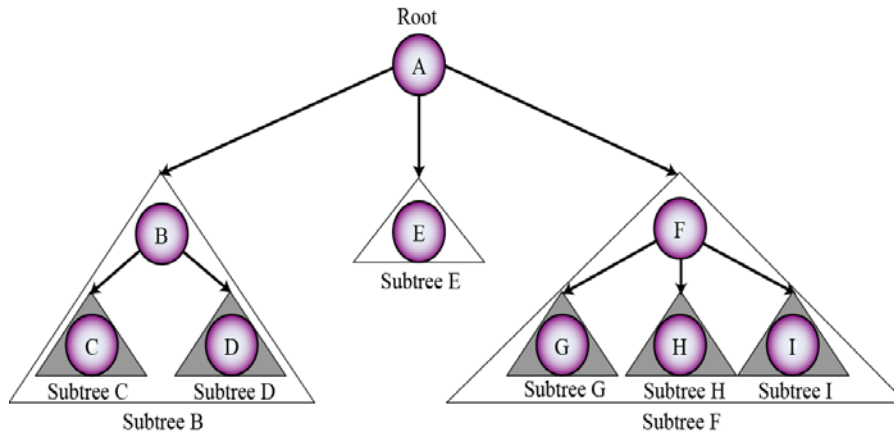

**Figure 12.21** Subtrees

12.55

Physical structure of a **tree**. each node includes one of its children and all descendants of that child.

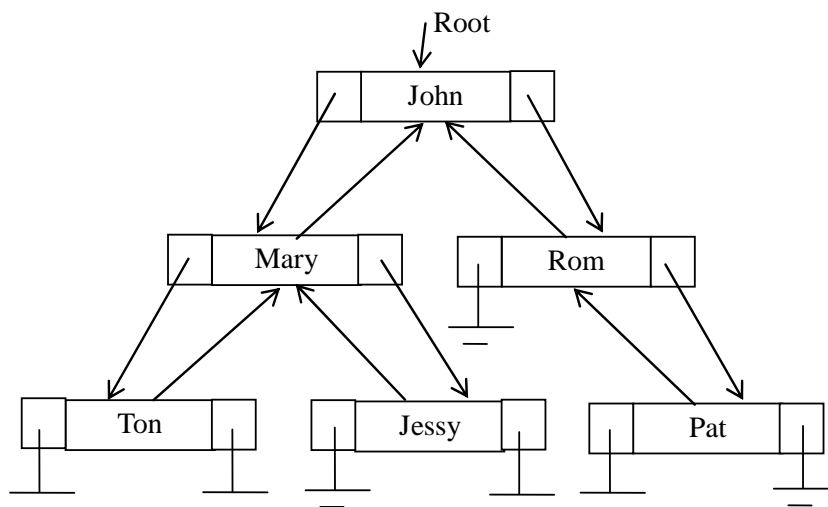

12.56

## 12-6 BINARY TREES

A binary tree is a tree in which no node can have more than two subtrees. In other words, a node can have zero, one or two subtrees.

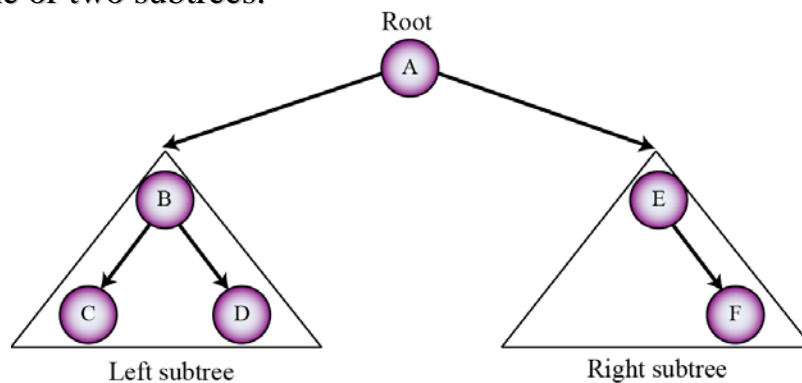

**Figure 12.22** A binary tree

12.57

### Recursive definition of binary trees

In Chapter 8 we introduced the recursive definition of an algorithm. We can also define a structure or an ADT recursively. The following gives the recursive definition of a binary tree. Note that, based on this definition, a binary tree can have a root, but each subtree can also have a root.

#### *Binary tree*

**Definition** A binary tree is either empty or consists of a node, *root*, with two subtrees, in which each subtree is also a binary tree.

12.58

Figure 12.23 shows eight trees, the first of which is an empty binary tree (sometimes called a null binary tree).

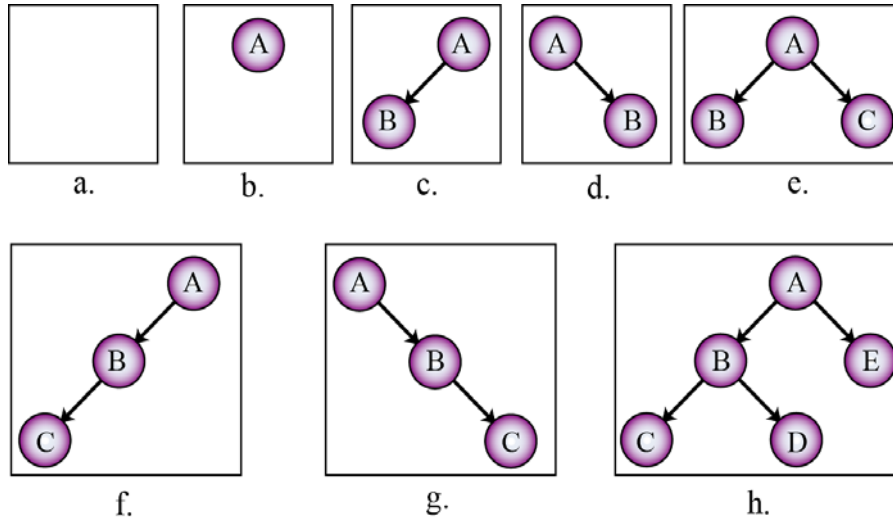
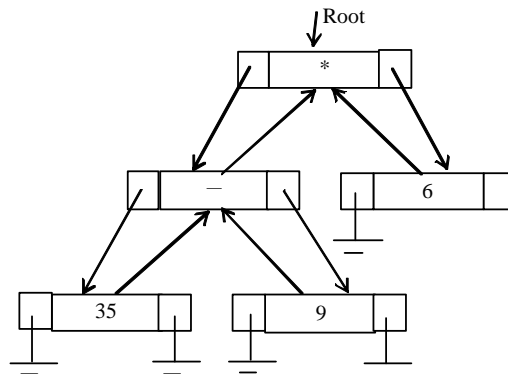

Figure 12.23 Examples of binary trees

12.59

## Operations on binary trees

The **six most common operations** defined for a binary tree are *tree* (creates an empty tree), *insert*, *delete*, *retrieve*, *empty* and *traversal*. The first five are complex and beyond the scope of this book. We **discuss binary tree traversal** in this section.



12.60

## Binary tree traversals

A binary tree traversal **requires that each node of the tree be processed once** and only once in a predetermined sequence. The two general approaches to the traversal sequence are **depth-first** and **breadth-first** traversal.

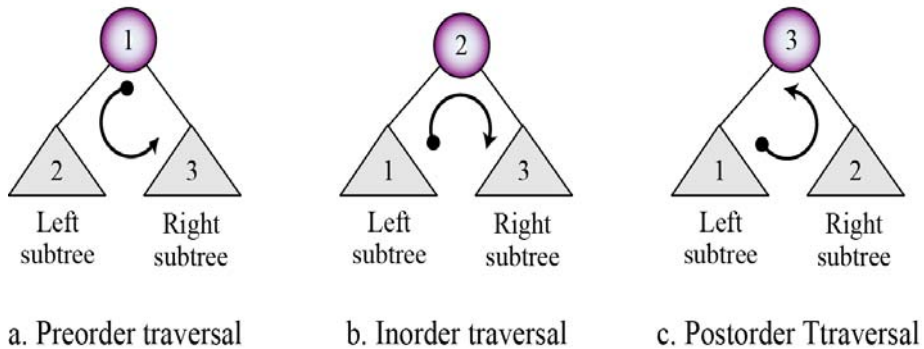
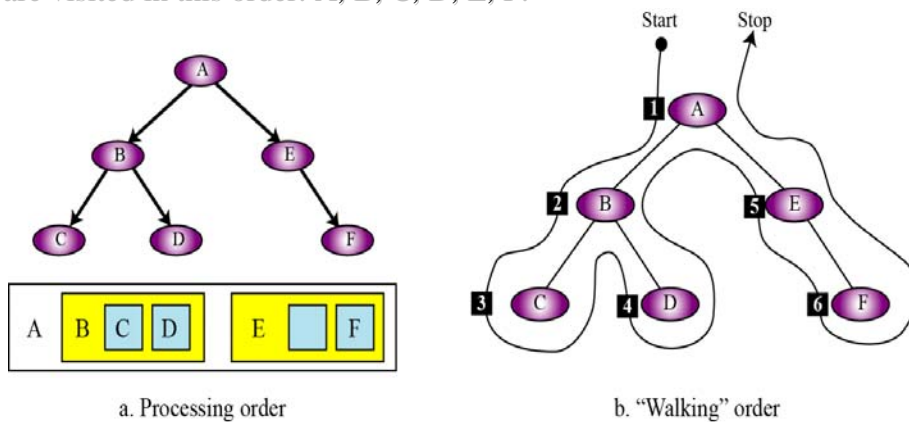

**Figure 12.24** Depth-first traversal of a binary tree

12.61

## Example 12.10

Figure 12.25 shows how we **visit each node in a tree using preorder traversal**. The figure also shows the walking order. In preorder traversal we visit a node when we pass from its left side. The nodes are visited in this order: A, B, C, D, E, F.



**Figure 12.25** Example 12.10

12.62

### Example 12.11

Figure 12.26 shows how we **visit each node in a tree using breadth-first traversal**. The figure also shows the walking order. The traversal order is A, B, E, C, D, F.

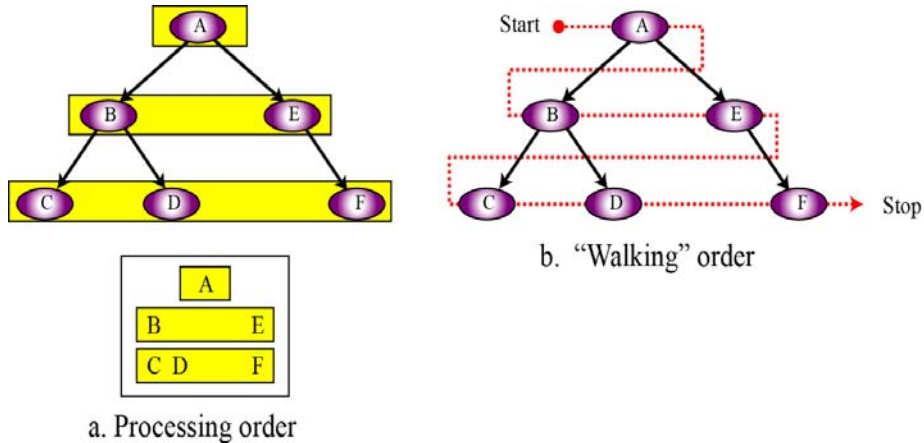

Figure 12.26 Example 12.11

12.63

## Binary tree applications

Binary trees have many applications in computer science. In this section we mention only two of them: **Huffman coding** and **expression trees**.

### Huffman coding

Huffman coding is a **compression technique** that uses binary trees to generate a variable length binary code from a string of symbols. We discuss Huffman coding in detail in Chapter 15.

12.64



## Expression trees

An arithmetic expression can be represented in three different formats: **infix**, **postfix** and **prefix**. In an infix notation, the operator comes between the two operands. In postfix notation, the operator comes after its two operands, and in prefix notation it comes before the two operands.

These formats are shown below for addition of two operands A and B.

**Prefix:** +AB

**Infix:** A+B

**Postfix:** AB+

12.65

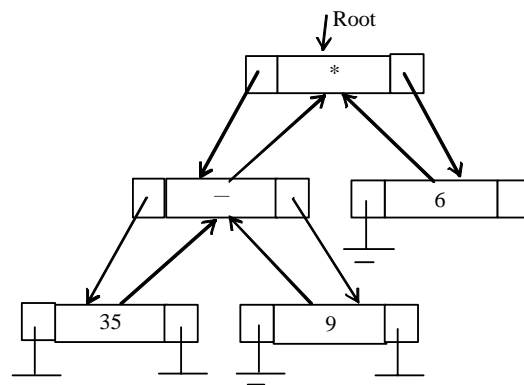

12.66

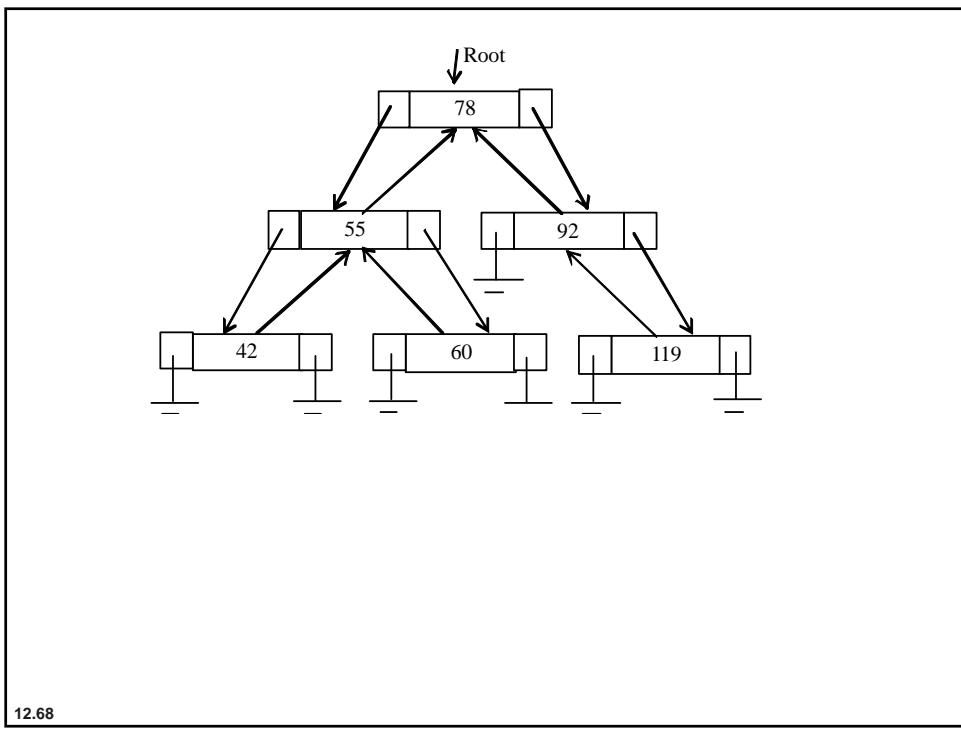
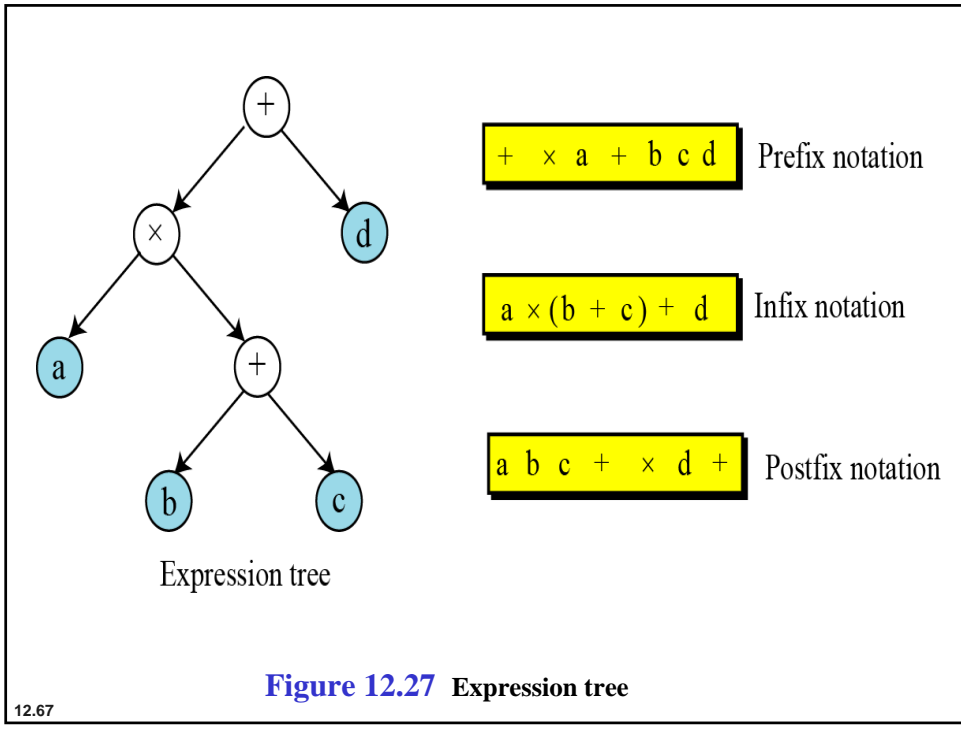

## 12-7 BINARY SEARCH TREES

A binary search tree (BST) is a binary tree with one extra property: the key value of each node is greater than the key values of all nodes in each left subtree and smaller than the value of all nodes in each right subtree. Figure 12.28 shows the idea.

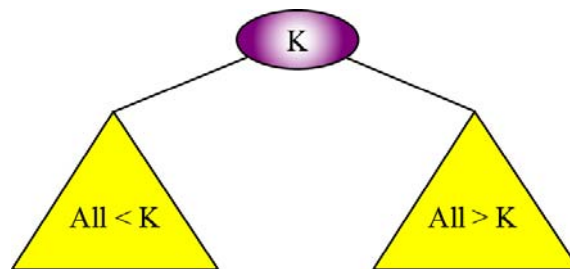
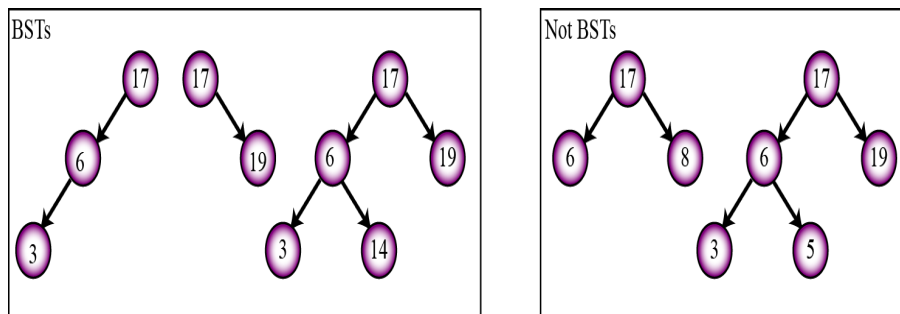

**Figure 12.28** Binary search tree (BST)

12.69

### Example 12.12

Figure 12.29 shows some binary trees that are BSTs and some that are not. **Note that a tree is a BST if all its subtrees are BSTs and the whole tree is also a BST.**



**Figure 12.29** Example 12.12

12.70

A very interesting property of a BST is that if we apply the inorder traversal of a binary tree, the elements that are visited are sorted in ascending order. For example, the three BSTs in Figure 12.29, when traversed in order, give the lists (3, 6, 17), (17, 19) and (3, 6, 14, 17, 19).

**An inorder traversal of a BST creates a list that is sorted in ascending order.**

12.71

Another feature that makes a BST interesting is that we can use a version of the binary search we used in Chapter 8 for a binary search tree. Figure 12.30 shows the UML for a **BST search**.

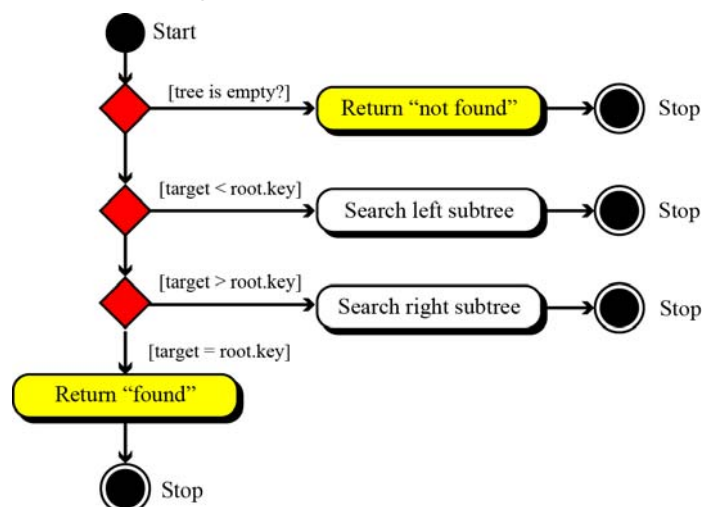

**Figure 12.30** Inorder traversal of a binary search tree

12.72

## Binary search tree ADTs

The ADT for a binary search tree is similar to the one we defined for a general linear list with the same operation. As a matter of fact, we see more BST lists than general linear lists today. The reason is that searching a BST is more efficient than searching a linear list: a general linear list uses sequential searching, but BSTs use a version of binary search.

12.73

## BST implementation

BSTs can be implemented using either arrays or linked lists. However, linked list structures are more common and more efficient. The implementation uses nodes with two pointers, left and right.

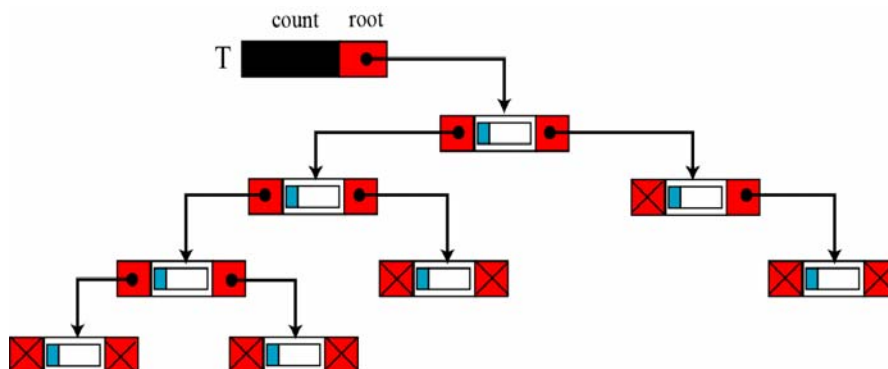

Figure 12.31 A BST implementation

12.74

## 12-8 GRAPHS

A graph is an ADT made of a set of nodes, called **vertices**, and set of lines connecting the vertices, called **edges** or **arcs**. Whereas a tree defines a hierarchical structure in which a node can have only one single parent, each node in a graph can have one or more parents. Graphs may be either **directed** or undirected. In a directed graph, or **digraph**, each edge, which connects two vertices, has a direction from one vertex to the other. In an undirected graph, there is no direction. Figure 12.32 shows an example of both a directed graph (a) and an undirected graph (b).

12.75

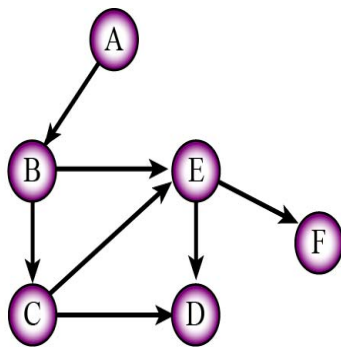

a. Directed graph

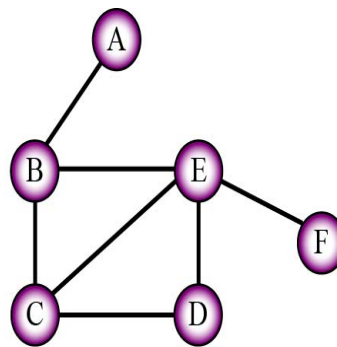

b. Undirected graph

**Figure 12.32** Graphs

12.76

### Example 12.13

**A map of cities and the roads connecting the cities can be represented in a computer using an undirected graph.** The cities are vertices and the undirected edges are the roads that connect them. If we want to show the distances between the cities, we can use weighted graphs, in which each edge has a weight that represents the distance between two cities connected by that edge.

### Example 12.14

Another application of graphs is in **computer networks** (Chapter 6). **The vertices can represent the nodes or hubs, the edges can represent the route.** Each edge can have a weight that defines the cost of reaching from one hub to an adjacent hub. A router can use graph algorithms to find the shortest path between itself and the final destination of a packet.

12.77